

User's Manual

Radar People Counter

FP601

Contents

1. Product Structure	3
1.1 Packing List	3
1.2 Product Size	3
1.3 Appearance Function	4
2. Installation Instructions	5
2.1 Site Investigation Concerns	5
2.2 Preparatory Instructions	5
2.3 Installation Height	6
2.4 Equipment Installation Precautions	8
3. Installation Steps	9
3.1 Wall Mounting Installation	9
3.2 Top Installation	10
4. Equipment Connection and Start-up	11
4.1 Login	11
4.2 Change the login password for the first time and set the installation parameters	13
4.3 WiFi network configuration and AP hotspot modification of the device	15
4.4 Platform Configuration	15
4.5 The statistical Area is Drawn in Detail	16
4.6 The Wire Drawing is Detailed	20
4.7 Shielding Area is Drawn in Detail	22
5. Common Problems	22
5.1 Login Related Issues	22
5.2 Regional Data Inaccuracy Related Problems	23
5.3 Common Problems of Regional Alarm and Target Detection	24
5.4 The Target Detection Setting Interface is Configured in Detail	25
5.5 Common Problems in the Use of Wire	26
5.6 Upgrade Maintenance Related Issues	27
6. Upgrade Maintenance	27
6.1 The Alarm Setting Interface is Configured in Detail	27
6.2 The Report Configuration is Detailed	30

1. Product Structure

1.1 Packing List

- Product Pictures



Front

1.2 Product Size

unit:mm

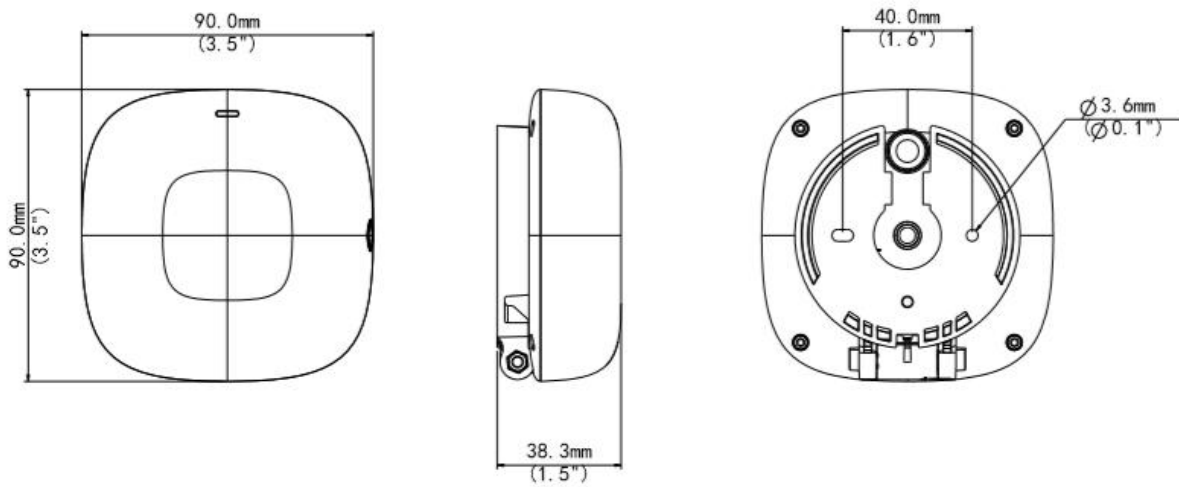

1.3 Appearance Function

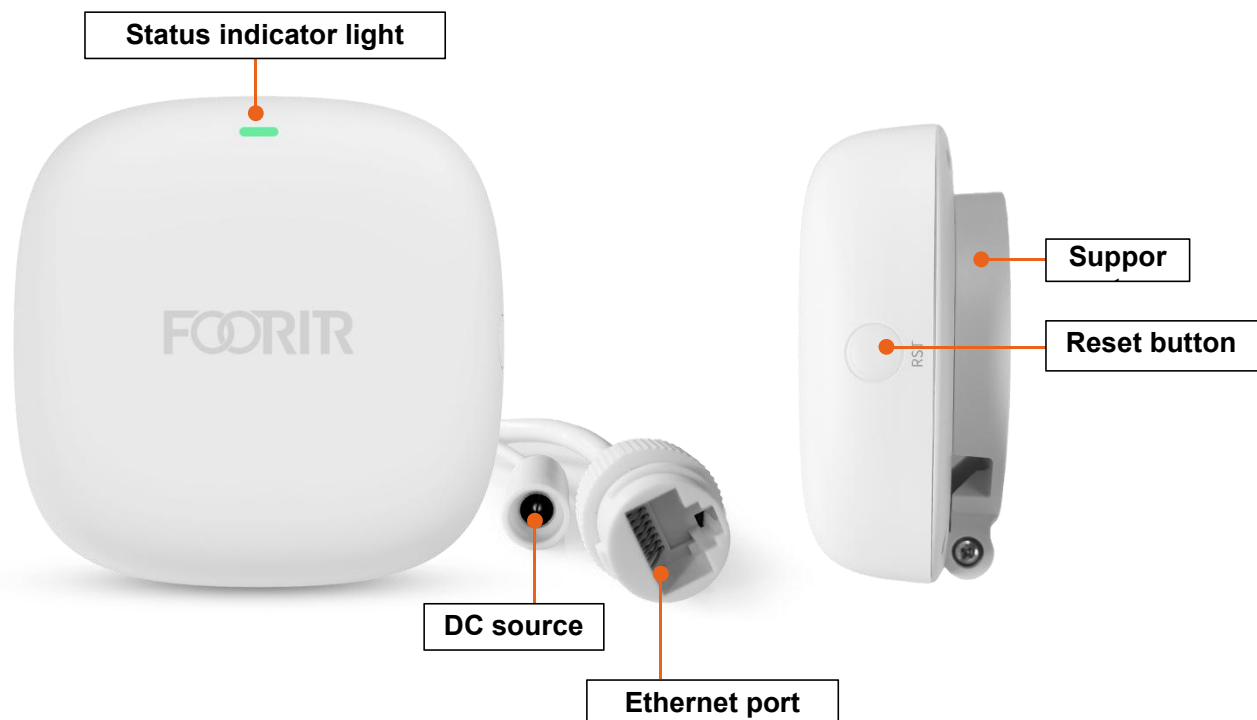

Name	Explain
Status indicator light System running status	Yellow light on: Starting (device powered on) Yellow light flashing: upgrade process Green light is always on: it is always on for 3 seconds after the distribution network is successful Red light on: Resetting (long press the reset button for 10 seconds, red light on for 3 seconds to enter the reset mode) Red light flashing: equipment is abnormal Off: Normal operation
Ethernet port	RJ45 port /PoE port
DC source	5.5-2.1 Power interface (9-36V)
Reset button	Long press the circular button on the side of the device for 10s until the red light is always on. The password is restored to the default value of 123456







2. Installation Instructions

2.1 Site Investigation Concerns

- ❖ **Obstruction:** Radar detects objects by emitting electromagnetic waves and reflecting electromagnetic waves. If there are many obstacles in the target area from radar to the target area, it may lead to poor detection effect of radar. When selecting points, try to ensure an unobstructed environment for radar.
- ❖ **Metal:** For electromagnetic waves, metal objects have higher reflection intensity than human body. If there are too many metal objects in the detection area, it is easy to cause false targets detected by radar. When selecting points, select areas with small and few metal objects.
- ❖ **Power supply:** ensure that the radar station has a stable and reliable power supply.
- ❖ **Power supply network:** Data transmission is an important part of radar system, and a stable network connection should be ensured for real-time data transmission and remote monitoring.
- ❖ **Construction convenience:** choose a location that is easy to construct and maintain to reduce construction and operation costs.

2.2 Preparatory Instructions

- **Prepare Installation Tools**

		
Electric drill	Hole opener + 6mm drill bit	Marker pen
		
Tape measure	Hammer	Phillips screwdriver

• Safety Precautions

⚠ The personnel responsible for the installation and daily maintenance of the equipment must have the basic skills of safe operation. Please read and strictly comply with the following safety operation specifications before using the equipment to avoid dangerous accidents and property losses.

⚠ Make sure the equipment is placed or installed in a stable and reliable manner to prevent falling.

⚠ Please prevent water or other liquids from entering the equipment to avoid damage to the equipment and the risk of electric shock, fire and so on.

⚠ Please ensure that the ambient voltage is stable and meets the power supply requirements of the equipment. Be sure to use the equipment within the rated input and output range, and pay attention to the overall power supply power is greater than the sum of the maximum power designed by the equipment.

⚠ When handling equipment, it is forbidden to handle it by pulling the tail line.

⚠ Disconnect power from mobile devices before use to avoid the risk of electric shock.

2.3 Installation Height

• Installation Example Description

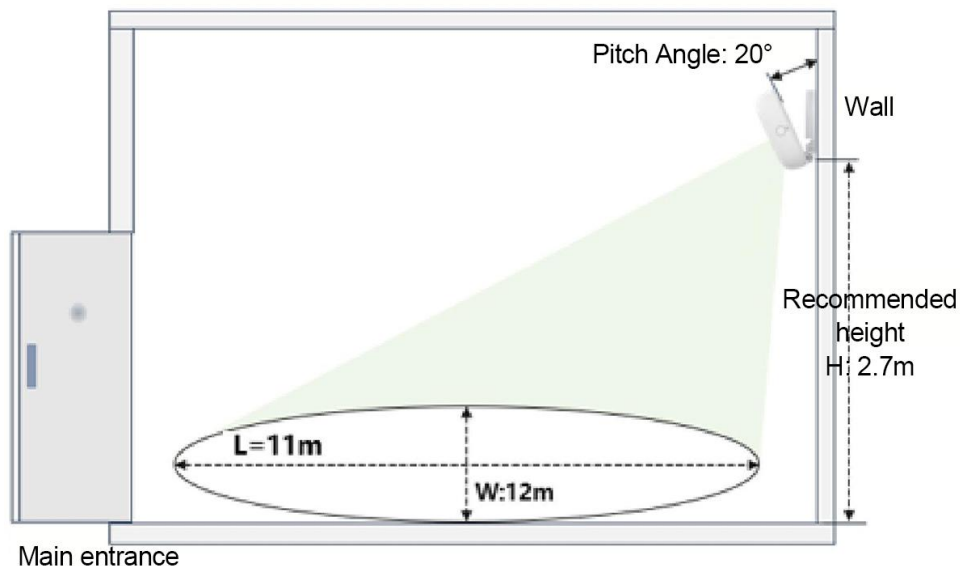

Wall mounting recommended installation diagram

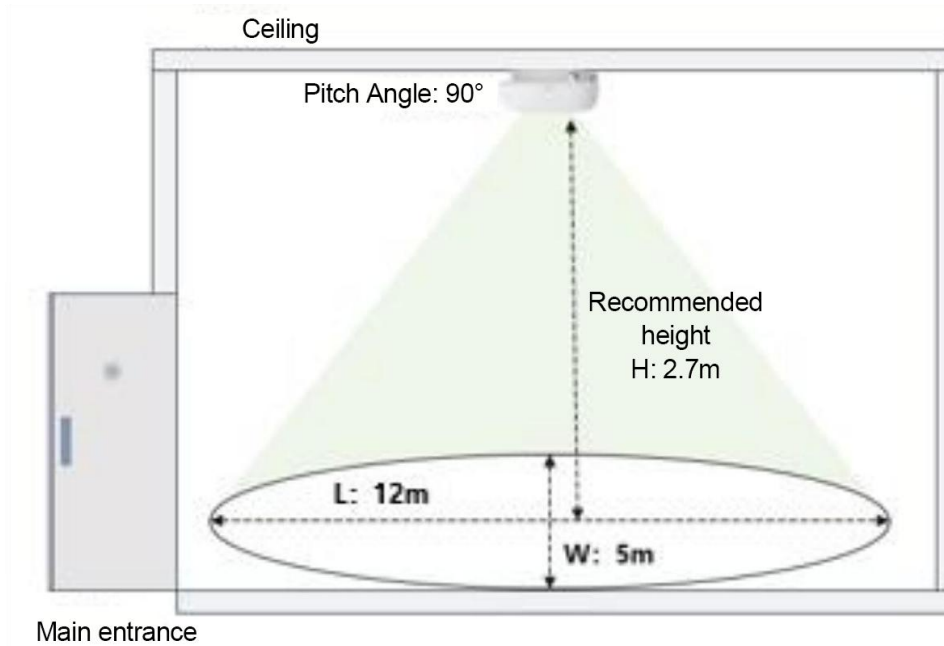

Top mounting recommended installation diagram

Way to Install	Wall Mounting	Top Mounting
Radar Installation Height (H)	2-4m	2-4.5m
Recommended Installation Height	2.7m	
Range of Radar Longitudinal Detection (L)	10.5-11m	5-12m
Range of Radar Lateral Detection (W)	12m	1.6-5m
Recommend Pitch Angle	20 °	90 °
Radar installation instructions	<ol style="list-style-type: none"> 1. Keep the UNV indicator light up when installing the radar wall; 2. When installing the radar on top, in order to ensure that the detection range of the radar covers the complete coverage, the detection range of the radar should be installed according to the size of the room; 3. As shown in the figure, the longitudinal detection range (L) of the radar is based on the direction parallel to the indicator light; the transverse detection range (W) of the radar is based on the direction parallel to the RST reset key; 4. When the installation height is in the range of [2,2.5) meters, the pitch Angle of the equipment is 10 °. When the installation height is in the range of [2.5,4.5) meters, the pitch Angle is adjusted to 20 °. 	

2.4 Equipment Installation Precautions

❖ Equipment installation method selection?

According to the actual situation, selecting an appropriate method for on-site investigation is essential to achieve the best detection results from the equipment; how to choose the method should be based on the complexity of the scene and the detection capabilities under different installation methods of the equipment; for ceiling-mounted installation, the radar detection range is significantly affected by the installation height; when the scene has a low ceiling but a large area, the ceiling-mounted installation method should not be used; for wall-mounted installation, the radar detection range is less affected by the installation height, but there are blind spots near the target due to physical obstructions. When the scene has a small area with many obstacles taller than the target, the ceiling-mounted installation method should also not be used.

❖ Installation method selection example!

Example 1: Conference room scenario

When the inspection range of the meeting room is large, wall mounting is preferred to be installed on the short side wall; if the floor height is high and the construction requirements are low, the top mounting method can be tried, which needs to meet the scene range within the radar dotted line detection range;

When the conference room scope is small, priority should be given to the use of top installation to ensure that the scene scope is within the radar dotted line detection range; if the floor height is low, the radar detection range does not meet the requirements or the top installation construction requirements are high, wall installation can be used (blind area exists).

Example 2: Supermarket scenario

Multiple devices are installed in medium and large supermarkets for combined detection. The floor height of supermarkets is generally high, so the top installation method is preferred. If the construction difficulty of the top installation is greater, the wall installation method can be adopted;

The small supermarket scene is similar to the conference room scene. Due to the shelf interference factor, the top mounting method is preferred.

⚠ When installed in the conference room scene, you need to enter the target detection setting interface and configure the scene mode to the conference room scene; when installed in the timeout scene, you need to enter the target detection setting interface and configure the scene mode to the timeout scene.

❖ Equipment installation and commissioning suggestions!

When installing the radar, priority should be given to the recommended engineering method for equipment installation. Under the condition that the scene allows, the radar can be adjusted appropriately;

Under the wall mounting, the radar pitch Angle can be adjusted appropriately to make the radar shine on the densely populated area;

Under the top installation, the horizontal radar position can be adjusted appropriately to make the radar shine on the densely populated area.

3. Installation Steps

3.1 Wall Mounting Installation

Step 1: Use the tape measure to measure the installation height, pay attention to keep the tape measure perpendicular to the ground when measuring, use a marker to mark the position where the equipment is to be installed, 2m~4m, recommended 2.7m.

Step 2: Attach the sticker to the marked equipment installation position, and the vertical direction of the sticker is perpendicular to the ground.

Step 3: Drill holes, insert the expansion tube into the wall, and use the expansion screw to fix the bracket, keeping the radar bracket connection at the bottom, as shown in the figure:

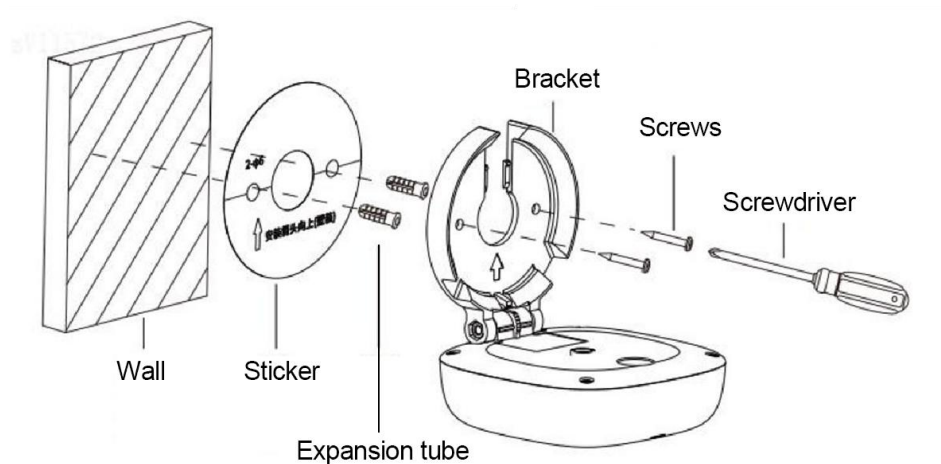

Schematic diagram of radar wall mounting

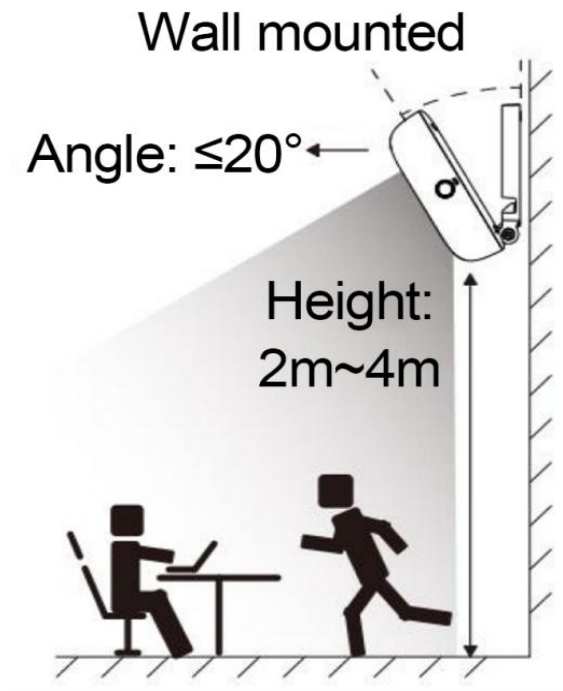

Schematic diagram of radar wall mounting Angle

3.2 Top Installation

Step 1: Use a tape measure to measure the installation height of the floor and ceiling. Note that the tape measure should be kept perpendicular to the ground when measuring, and mark the position where the equipment is to be installed with a marker pen. 2m~4.5m, 2.7m is recommended.

Step 2: Determine the installation direction of the radar. The Y axis of the radar corresponds to the short side direction of the scene (the direction of the indicator light), and the X axis corresponds to the long side direction. The sticker is attached to the marked installation position of the equipment, and the vertical direction of the sticker is perpendicular to the ground.

Step 3: Drive the expansion screw into the ceiling and use the expansion screw to fix the bracket, keeping the radar bracket connection below, as shown in the figure:

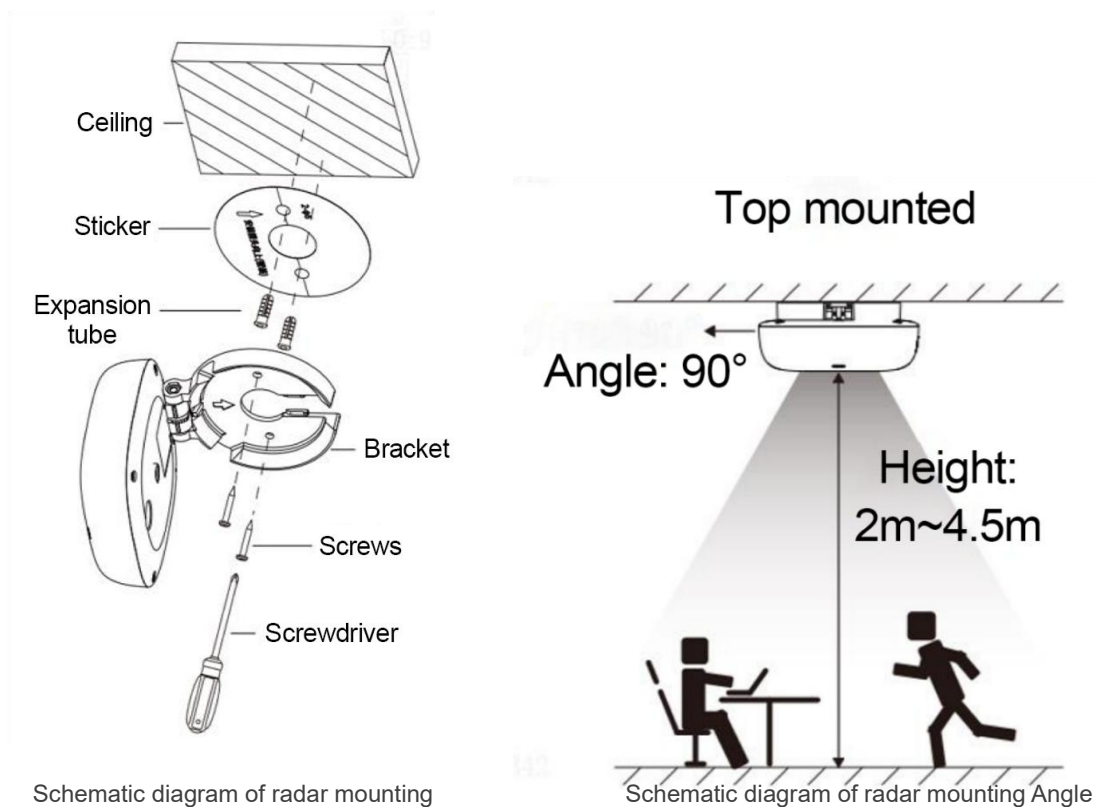

4. Equipment Connection and Start-up

4.1 Login

Step 1: After the device is powered on, the indicator light will be solid yellow. Once the indicator light turns off, open your phone's Wi-Fi settings and connect to the device's hotspot. The network name is RDN323-xxx, followed by the last nine digits of the serial number (the serial number can be found on the label on the back of the device), and the password is: 12345678.

Open the mobile browser, after the network is successfully connected, the green light will be on for 3s, and the normal operation will be extinguished;

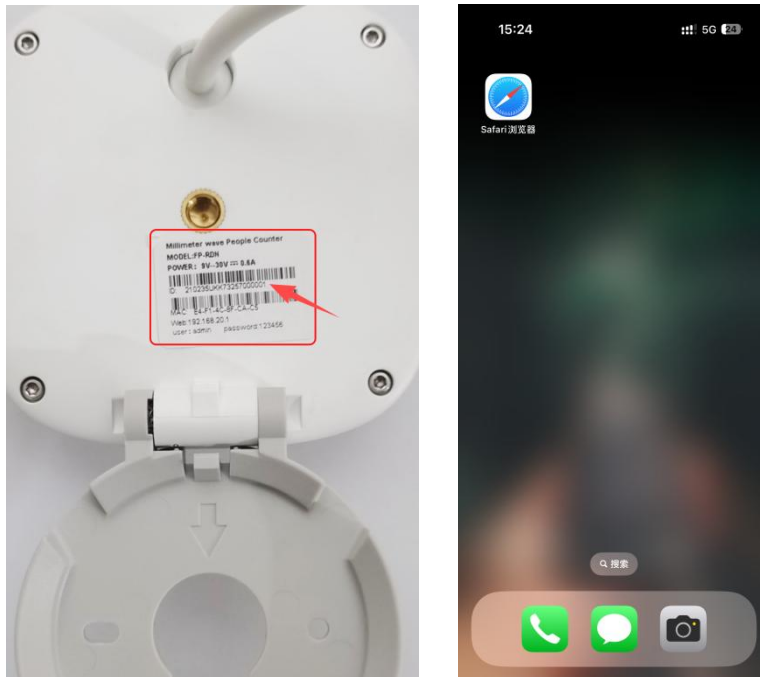

Step 2: After clicking the connection, the browser is opened to log in the radar interface and enter the IP address: 192.168.20.1. The operation steps are as follows (Apple is an example, Android is the same):



Step 3: Enter the default user name admin and password 123456, check I have read the privacy policy, and click login to enter the device.

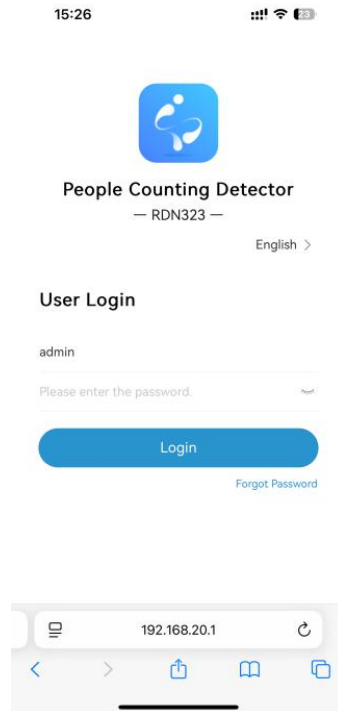

4.2 Change the login password for the first time and set the installation parameters

Initial login password modification: After the first successful login, you will enter the initial login password modification interface. After entering the content according to the prompt information, click next to complete the configuration and enter the installation configuration interface;

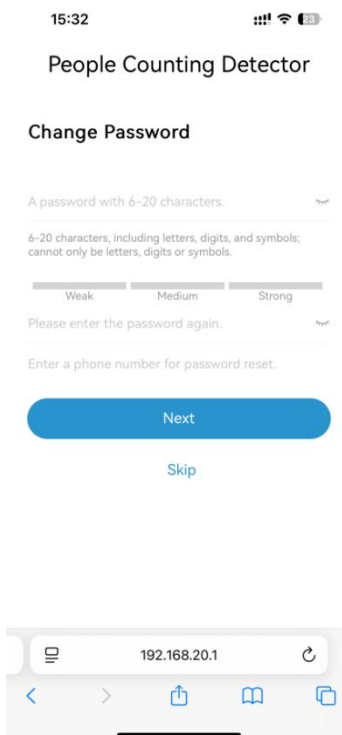

Configuration and Installation Method: According to the actual on-site installation method, configure the corresponding installation method on the interface. The configured installation height should be consistent with the actual installation height. The angle mode should be set to automatic or manual. The pitch angle should be configured according to the recommended survey angle, and the physical pitch angle of the equipment should be adjusted to be consistent with the configured pitch angle and saved. Then click the confirm button to enter the WiFi configuration interface.

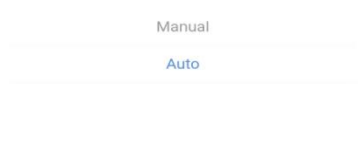
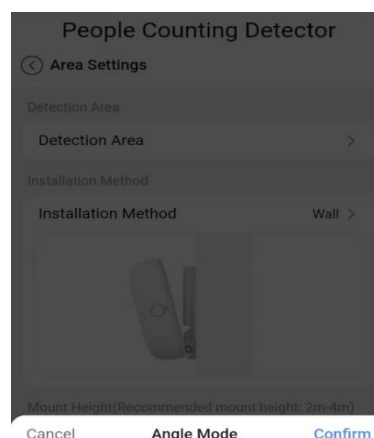
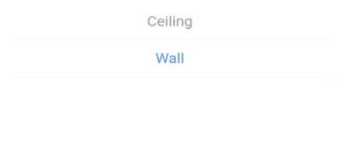
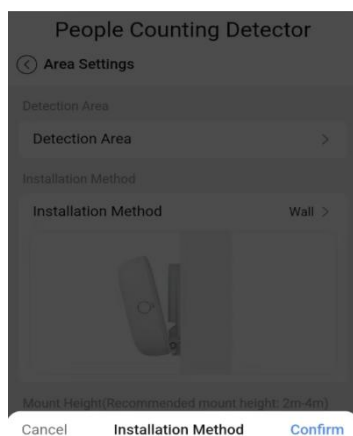

Configuration installation mode:

1. Select the installation mode

2. Select the angle mode

⚠ On the installation configuration parameters page, the device automatically identifies the Angle. Using the page-identified Angle as a reference, if the actual measured Angle is within 2° of the page-identified Angle, no adjustment to the device Angle is required; if the deviation is more than 2° , the device Angle must be adjusted so that the Angle of Roll and Angle of Horizontal meet the error requirement of $\pm 2^\circ$

4.3 WiFi network configuration and AP hotspot modification of the device

WiFi configuration: select the device WiFi name, enter the WiFi password, click the next button, enter the device AP configuration interface;

Device AP configuration: you can customize and modify the device AP information according to the prompt information; click the next button to enter the platform configuration interface;

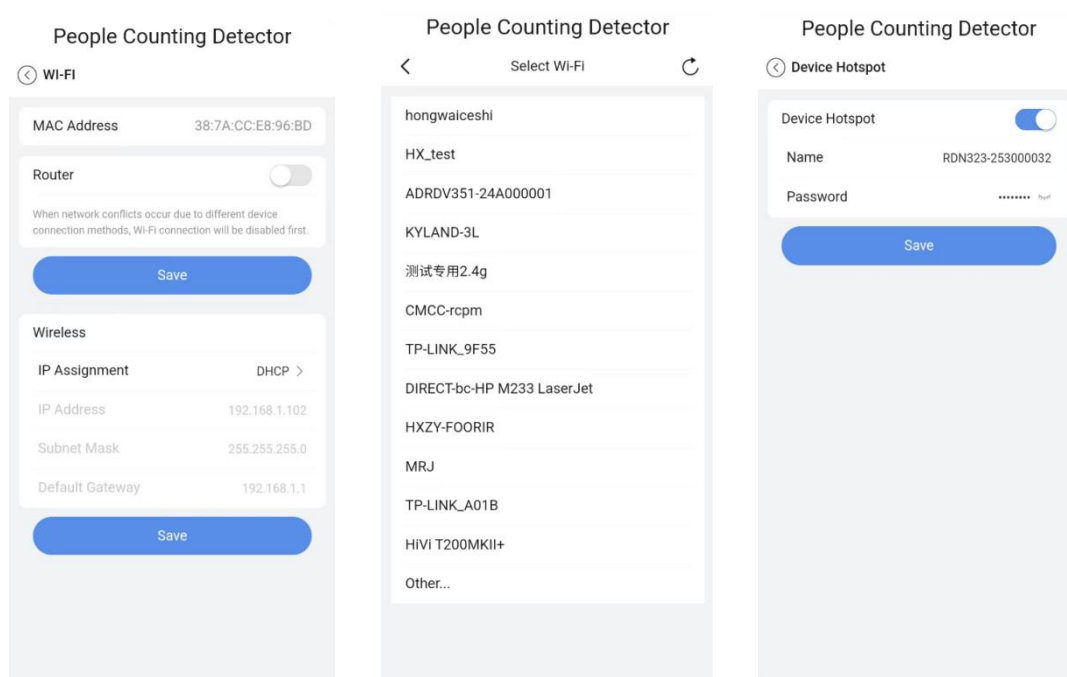

Turn on the router and select WiFi and enter the password

WiFi selection list

Modify the device hotspot and password

4.4 Platform Configuration

Step 1: Start platform docking according to the actual platform docking requirements.

Step 2: Select the corresponding protocol according to the requirements, configure the platform address, and click complete.

If using the official platform, enter the configuration platform address:

op.foorir.com:8977, and the secret key: admin#123, then click "Complete".

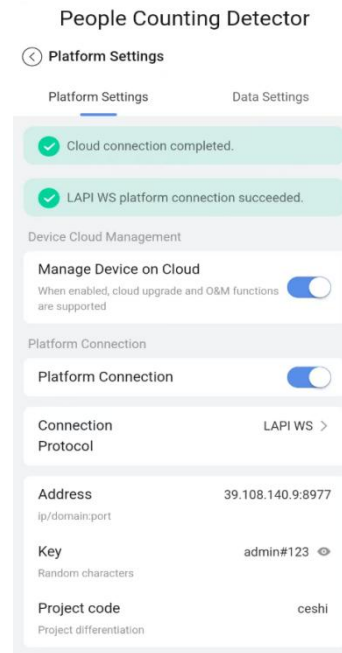
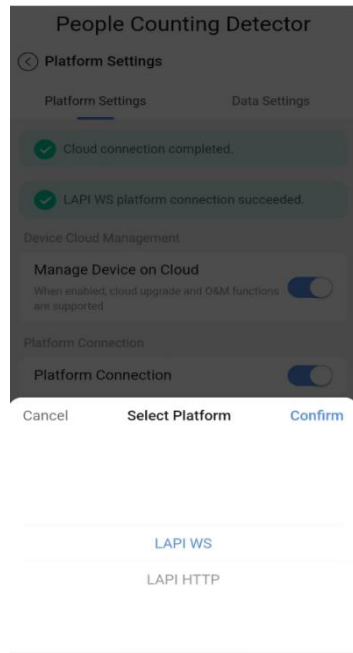

Step 3: Check the device's SN (serial number) and add it to the platform (server).

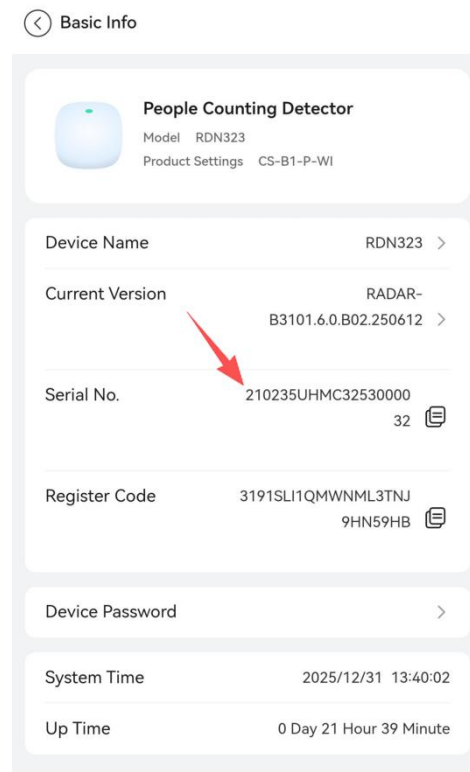
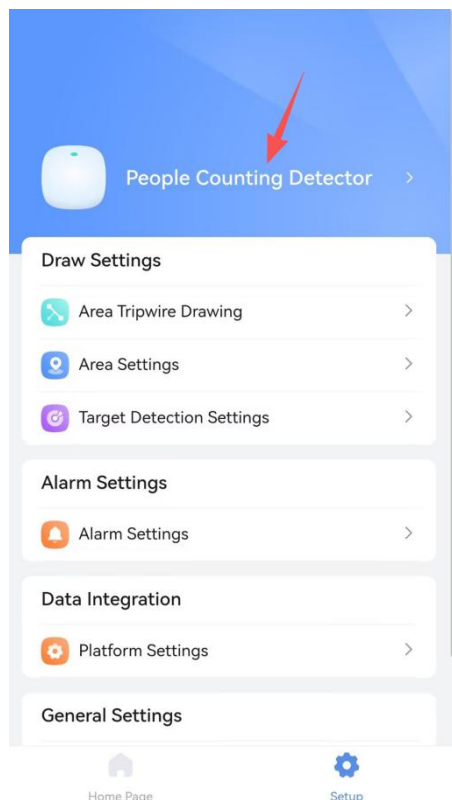

4.5 The Statistical Area is Drawn in Detail

4.5.1 Drawing:

Step 1: Enter the [Home] -- [Area Editing/Boundaries] -- [Area Drawing] interface.

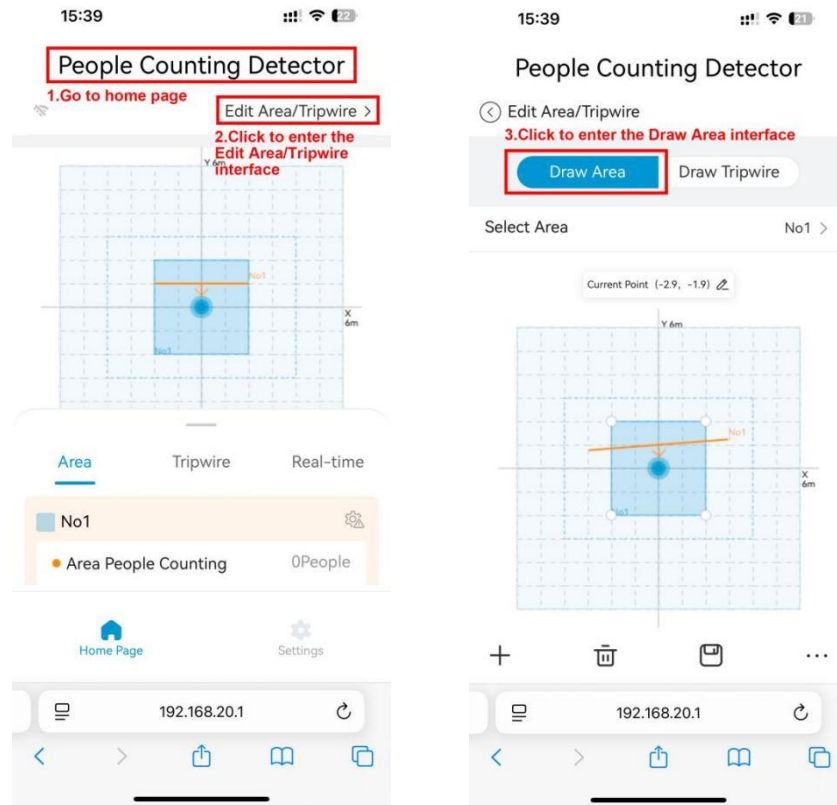

Step two: Set the detection area according to the actual size of the installation scene. Select the four corners of the light blue rectangular area on the canvas and drag them to adjust the size of the area. Click on the four corners of the canvas, and the configuration options at the top of the canvas will display the coordinates of the selected points. Click the edit icon on the right to edit the coordinates of the selected points, which supports manual input.

⚠ By means of statistical regional function, personnel presence detection can be carried out in the designated area within the detection range, and up to 6 areas can be configured;

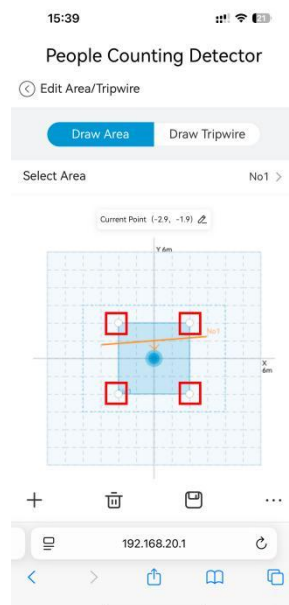

4.5.2 Added:

Step 1: Click the + icon in the lower left corner of the interface, and a new area will appear on the interface;

Step 2: Long press the selected area to drag and draw.

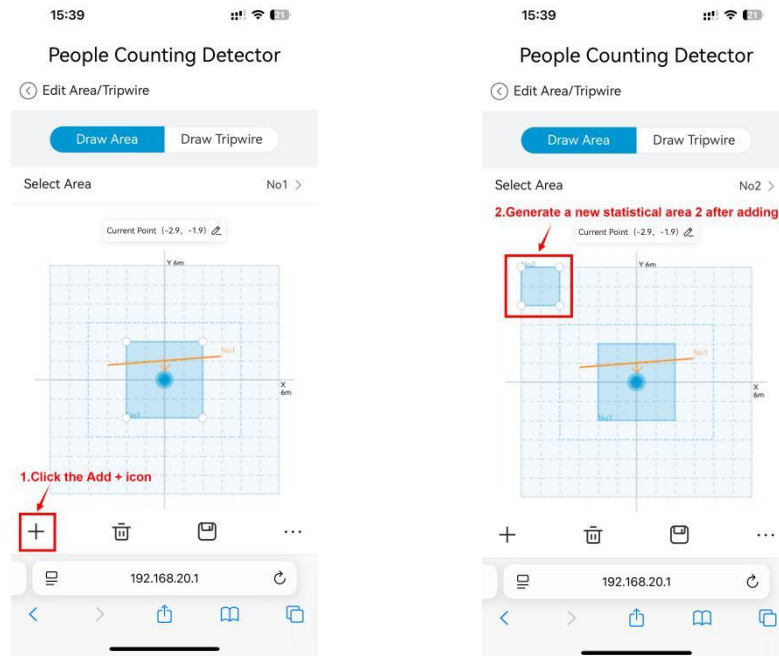

4.5.3 Delete:

Step 1: Click the current selected area option at the top of the interface and select the area to be deleted;

Step 2: Click the "Delete" icon at the bottom of the interface to delete the selected area.

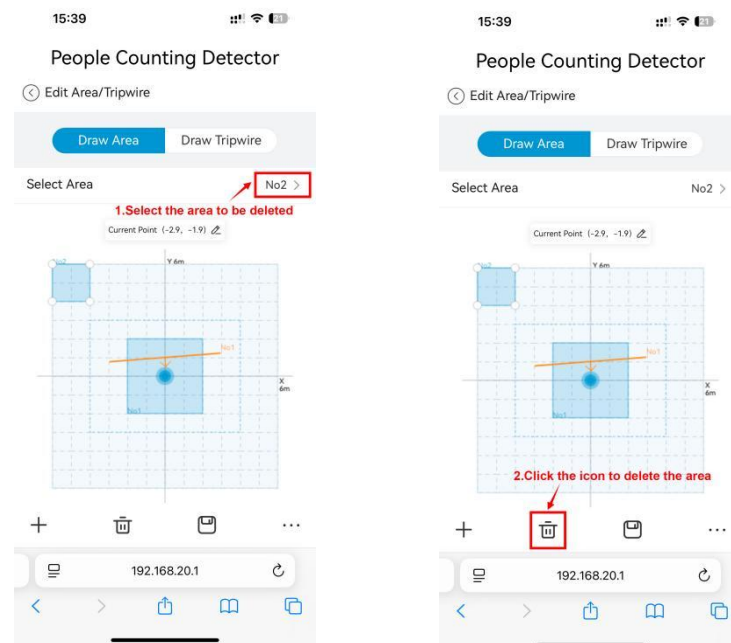

4.5.4 Preservation:

When there are drawing, adding, deleting, renaming and other operations in the regional configuration interface, you need to click the "Save" icon at the lower right corner of the interface to save the issued configuration content.

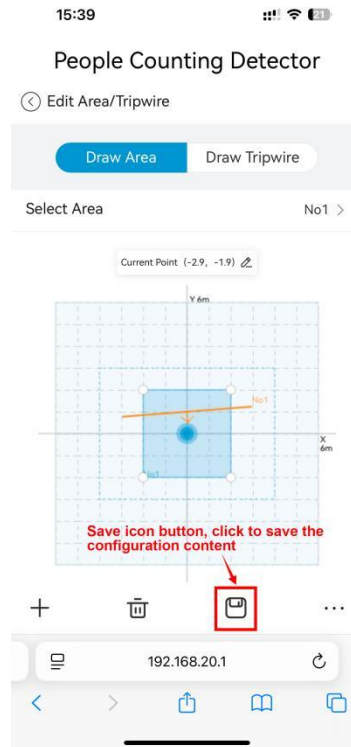

4.5.5 Renaming:

Step 1: Click the current selected area option at the top of the interface, and select the area to be renamed;

Step 2: Click the "More" icon at the bottom of the interface, click the rename option, enter the custom name, and click OK to complete the rename.

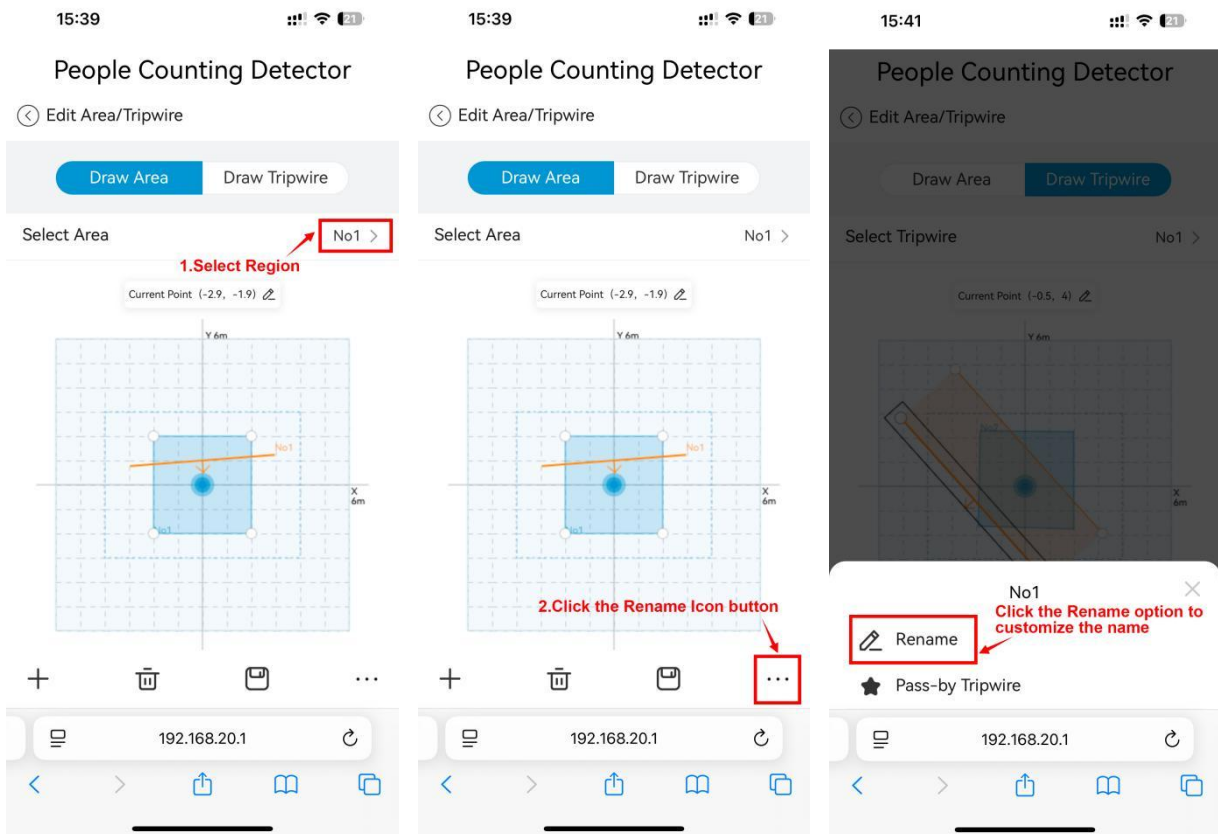

4.6 The Wire Drawing is Detailed

4.6.1 Wire drawing:

Step 1: Enter the [Home page] -- [Area editing / Bounce line] -- [Bounce line drawing] interface;

Step 2: Select the tether (default is only Tether 1), hold down to select, and drag the tether to the desired position. Select one end of the tether and rotate it to change its extension direction; you can also select both ends and input coordinates to draw a new tether; the arrow on the tether indicates the entry direction;

Step 3: After drawing is completed, click the "Save" icon at the bottom of the interface to save the issued configuration content.

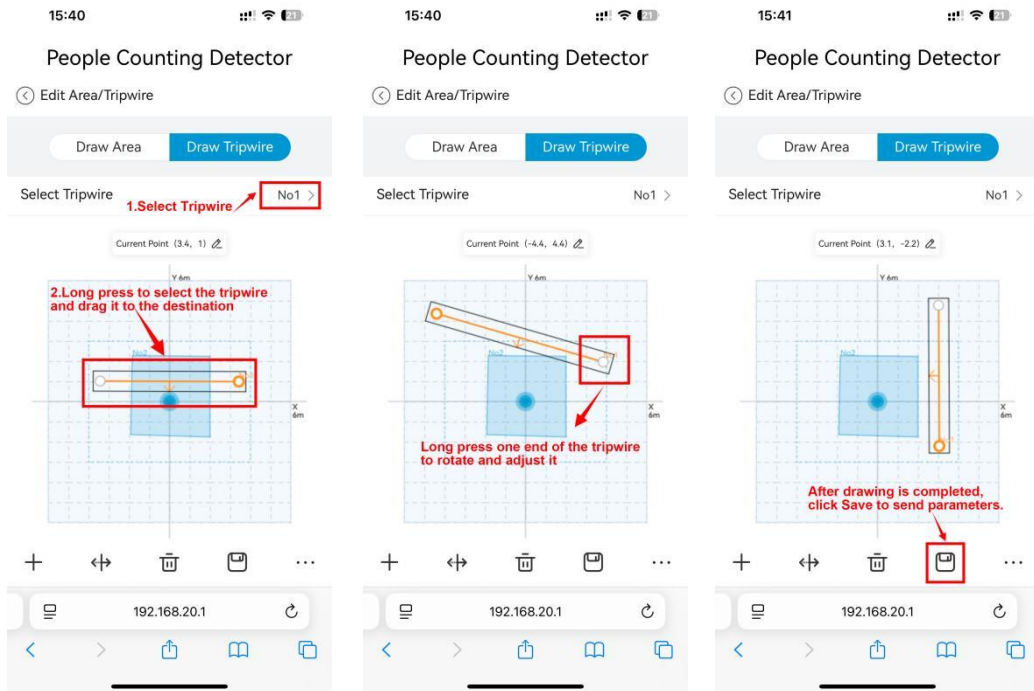

4.6.2 Path tripwire drawing:

Step 1: Enter the [Home page] -- [Area editing / Bump line] -- [Bump line drawing] interface, select one or add a new bump line;

Step 2: Click the "..." icon in the lower right corner, click set as path trap; Click the ends of the trap, you can drag or input coordinate values to draw the trap; select the end point of the intermediate area, input the length to modify the length of the intermediate area;

Step 3: After drawing is completed, click the "Save" icon at the bottom of the interface to save the issued configuration content;

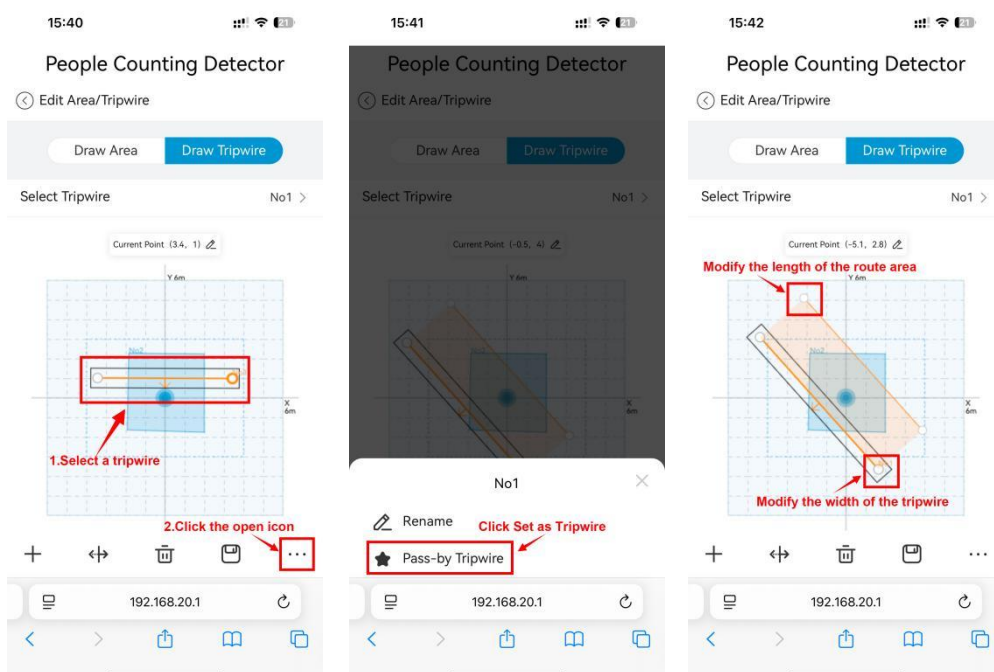

4.7 Shielding Area is Drawn in Detail

4.7.1 Detection Area Drawing:

Step 1: Enter the interface of [Area Configuration] -- [Detection Area] -- [Shielded Area].

Step 2: Click the + icon in the lower left corner of the interface to add a new blocking area.

Step 3: Long press the selected area, drag the area to the specified position, draw the area, the drawing method of the area is consistent with the detection area and statistical area,

Step 4: Click the "Save" icon in the lower right corner of the interface to save the issued configuration content;

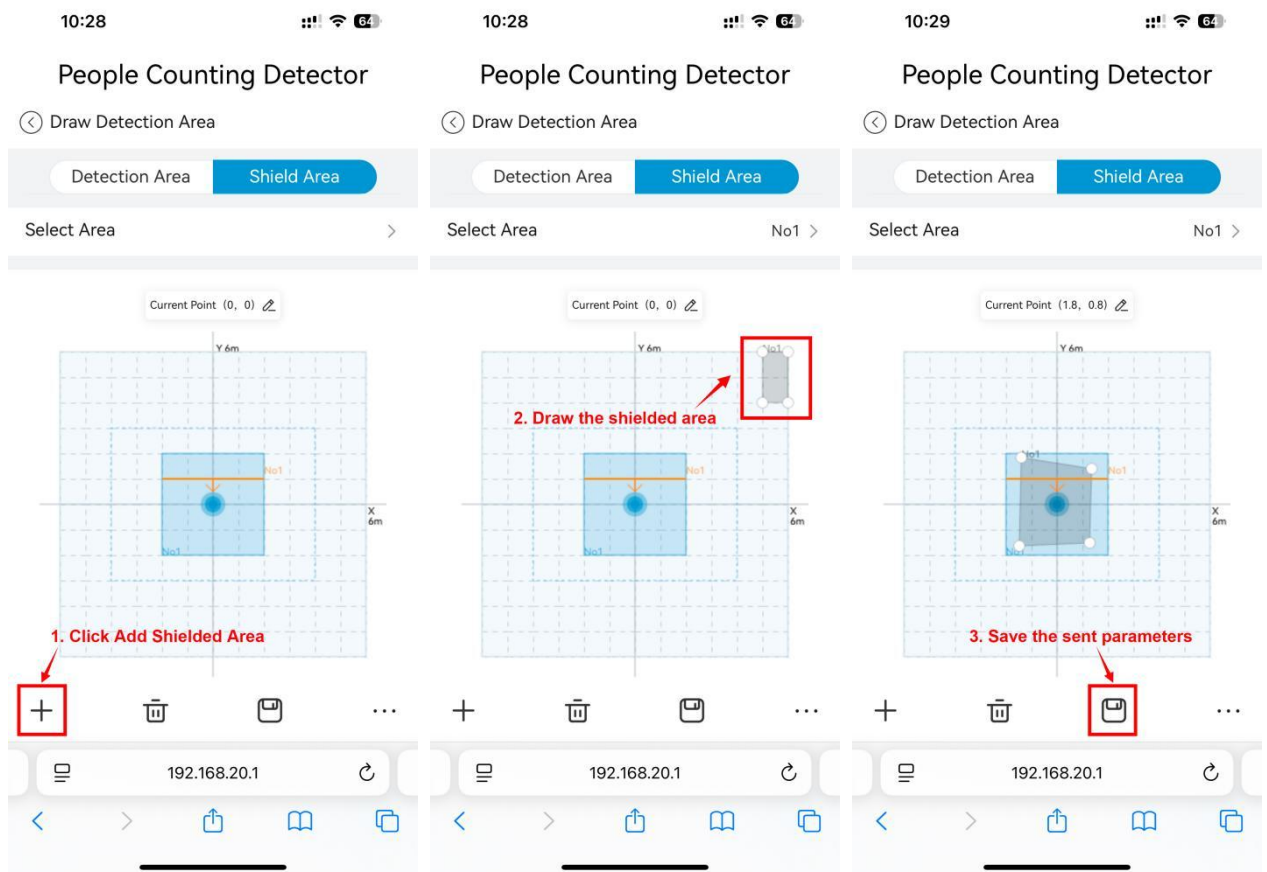

5. Common Problems

5.1 Login Related Issues

1. Q: How to retrieve the forgotten password?

1. There is a "Forget Password" option in the lower right corner of the login interface. Click it to retrieve the password according to the prompt;
2. Long press the circular button on the side of the device for 10s until the red light is

always on, and wait for the device indicator light to go out; Connect the hotspot of the radar, enter 192.168.20.1 in the browser, and log in with the default login password 123456.

2. Question: Login failed?

1. The current login interface may be the browser cache record. Enter the browser privacy setting interface and clear the browser cache;
2. Restart the radar after power failure.

3. Q: After entering 192.168.20.1 in the browser, I cannot adjust to the login interface?

1. Confirm whether the password is correct;
2. Confirm that the WLAN of the mobile phone has been connected to the radar hotspot;
3. Turn off the 4G data of your mobile phone and log in again;
4. Confirm whether the version of the operating system and browser configured on the terminal meets the requirements. The requirements of the operating system and browser are shown in the following figure:

PC end	operating system	It is recommended to use Microsoft Windows 10 and meet the minimum Microsoft Windows XP.
	browser	It is recommended to use Goole Chrome, 360 secure browser, Sogou browser, QQ browser; Currently, it is not recommended to use the browser: Microsoft Edge, Mozilla Firefox, UC browser.
mobile terminal	operating system	IOS14.3 and above /Android 12 and deep optimization system based on Android 12 and above.
	browser	It is recommended to use the native browser of the mobile phone, such as Xiaomi browser on Xiaomi phones, Huawei browser on Huawei phones, and Safari browser on Apple phones. The current supported browsers are: Baidu browser, QQ browser; Mobile browsers are not recommended at this time: UC browser, Quark browser.

5.2 Regional Data Inaccuracy Related Problems

1. Q: Can a single target of personnel in an area be split into multiple targets?

1. Enter the [Area Configuration] interface, confirm whether the installation method is accurate, and whether the installation height and Angle are consistent with the actual engineering survey;
2. Confirm whether the detection area is consistent with the actual scene size drawing; there are two methods as follows:

Method 1: Measure the length, width, height and radar position of the installation scene through the distance measurement tool. Then draw the area by dragging the four corners of the area to the specified position, or select the four corners of the area and input the coordinate value to draw the area;

Method 2: Enter the mobile radar, enter the [Home] -- [Real-time] page, personnel enter the scene, walk along the scene boundary, and observe the real-time location information of the target. When walking to the four boundary corners, record the coordinates of the target. Then when editing the detection area, input these four point coordinates;

2. Q: What is the difference between statistical area and detection area?

As the name suggests, the detection area is where radar detects targets. Only when personnel appear in this area can they be identified as targets; those outside the area are filtered out. The statistical area is where the system can perform statistics on targets within the region. This area can count the number of targets present, with an upper limit of 16 targets and a minimum of 0 targets;

3. Q: When the personnel are in the area, the detected target will disappear?

1. Enter the [Area Configuration] interface, confirm whether the installation method is accurate, and whether the installation height and Angle are consistent with the actual engineering survey;

2. Confirm whether there is physical obstruction between the target and the radar;

3. Confirm whether the detected area is consistent with the actual scene size;

4. Q: How to install the equipment and draw the area when the installation scene is large or irregular?

1. When the scene is large, it is recommended to use a combination of multiple devices to detect the scene situation;

2. When the scene is an irregular shape, multiple devices can be used to detect together to reduce the blind area range. In addition, when drawing the area, the blind corner range can be discarded and no statistics can be made;

5. Question: How to solve the problem when there are floating curtains, moving green plants and large fixed metal parts in the scene that can easily produce false targets?

Enter the [Area Configuration] = [Detection Area] -- [Shielded Area] interface, and draw a shielded area at the interference object to filter the interference object.

5.3 Common problems of regional alarm and target detection

1. Q: When the configuration area alarm is configured and the trigger alarm condition is reached, the area does not alarm?

1. Confirm whether the interface is stuck;

2. Click the Settings button in the upper right corner of the main interface to enter the [Alarm Settings] page, and confirm whether the alarm setting function is enabled. It may not be in the alarm period.

2. Q: How to solve the problem when the personnel are near the device and the target detection is slow?

The radar pitch Angle can be adjusted appropriately to increase ($\leq 5^\circ$)

3. Q: How to solve the problem when the radar detected target is different from the actual one in the meeting scene?

1. Confirm whether the detection area is consistent with the actual scene size;
2. Confirm whether the installation parameters in the [Area Configuration] interface are consistent with the actual site survey of the scene;
3. Click the Settings button in the upper right corner of the main interface to enter the [Target Detection Settings] page, and configure the usage scenario as the conference room scene.

4. Q: How to solve the problem when there are some high interference targets (pets, sweeping robots, moving shopping carts, sofas, etc.) in the scene?

You can try to filter the interference target through the high filtering function. See the next page for details of the configuration of the high filtering function.

5. In the wire trap, there are people wandering around, which leads to abnormal counting of the wire trap. How to deal with it?

The anti-wandering function can be enabled to solve the problem of abnormal target wandering count. For details of the configuration of the anti-wandering function, see the next page.

5.4 The target detection setting interface is configured in detail

Entry mode: Click the "Settings" icon in the upper right corner of the home page to enter the main configuration interface, and then click the target detection Settings option to enter the target detection Settings interface;

Default value: see Figure 1;

Prevent wandering: When there is a target hovering at the line, this function can be opened. For the final result of the wandering target, only one line count is made to avoid repeated counting;

High filtering: When the high filtering function is enabled, the interference targets at this height are filtered by configuring the upper limit value of high filtering to improve the detection effect of radar;

Scenario: Configure the corresponding detection mode according to the actual installation scenario of the device. Currently, the supported configuration modes include default scenario, shopping mall scenario, conference room scenario and supermarket scenario.

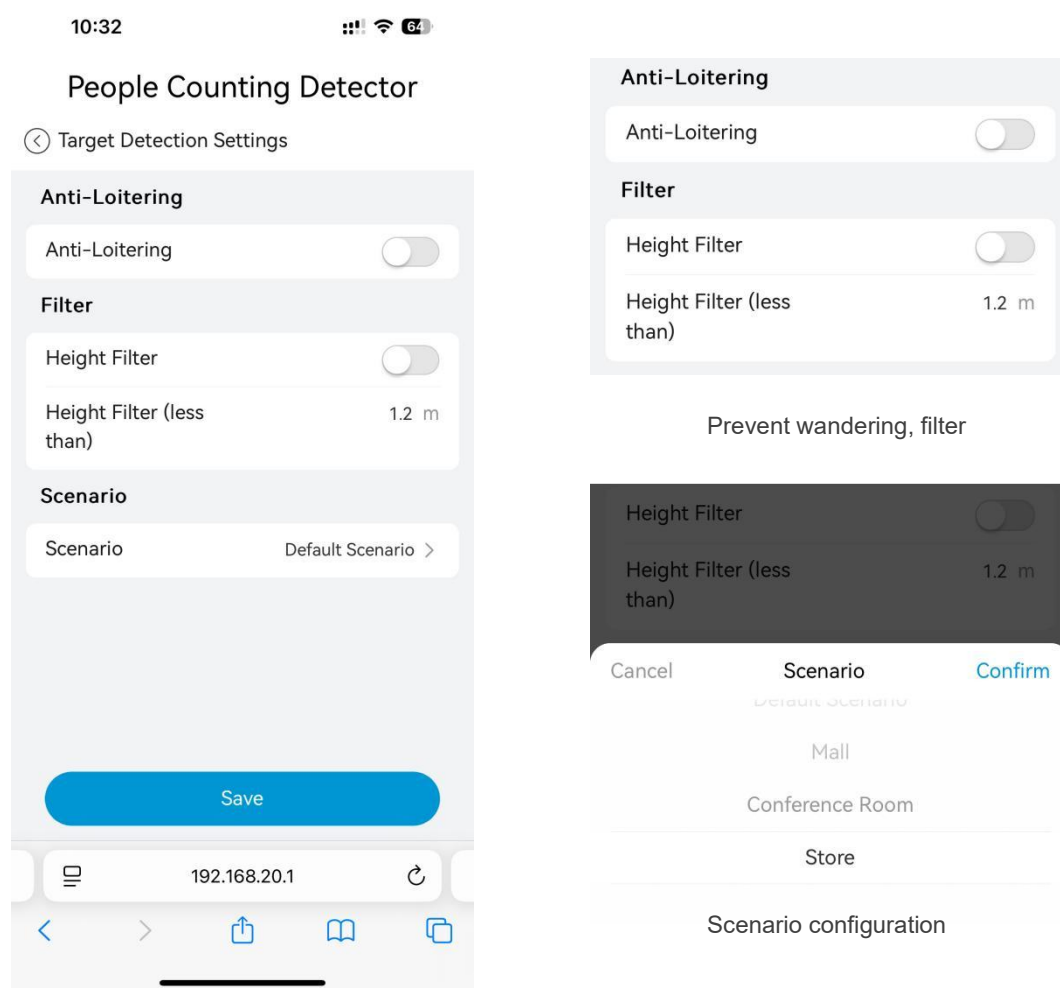

5.5 Common Problems in the Use of Wire

1. Q: When a person passes through the wire, the counting in and out is opposite to the actual one?

The arrow pointing to the direction of the line is forward. Make sure that the arrow direction is consistent with the actual entry direction

1. Q: How do I clear Tripwire statistics?

There are three ways to clear the data:

Method 1: Enter [Home] -- [Boulevard] interface, click the one-click clear button to clear all the current boulevard traffic statistics data;

Mode 2: Enter the [Home Page] -- [Boulevard] interface, find the target boulevard, click the "clear" icon on the right of the boulevard name column to clear the specified boulevard traffic statistics data;

Mode 3: Click the "Settings" icon in the upper right corner of the home page to enter the main configuration interface. Then click to enter the data setting interface, configure the cumulative number of people and clear frequency parameters, and clear the traffic data of the line by day, week or month, with the default frequency being day;

5.6 Upgrade Maintenance Related Issues

1. Q: How to restore the default configuration of radar?

1. Method (1) Enter the [Related Configuration] - [Upgrade and Maintenance] page, click the restore factory button to restore the factory;
2. Method (2) Long press the circular button on the side of the device for 10s until the red light is always on, and then restore to factory;

2. Q: How to manually restart the radar?

1. Enter the [Related Configuration] - [Upgrade and Maintenance] page, click the manual restart button to restart the radar;

3. Q: How does radar upgrade locally?

1. Enter the [Related Configuration] - [Upgrade and Maintenance] page, click local upgrade, and select the version package of radar to upgrade;

4. Q: How do I export device log information?

1. Enter the [Related Configuration] - [Upgrade and Maintenance] page, click the log export button to export the log information. The log path is under the download path of the browser;

5. Q: When there are multiple device hotspots in a room, how can you confirm which one is the specific device?

Enter the [Network Configuration] page, click the manual light button, and the green light flashes (the green light flashes for 30s) to connect the device;

6. Q: The equipment has a variety of light languages. What is the meaning of the specific light language?

Yellow light on: startup (device powered on)

Yellow light flashing: upgrade process

Green light always on: it will be on for 3 seconds after the distribution network is successful

Red light on: Resetting (long press the reset button for 10 seconds, red light on for 3 seconds to enter the reset mode)

Red light flashing: equipment is abnormal

Off: Normal operation

6. Upgrade Maintenance

6.1 The alarm setting interface is configured in detail

6.1.1 Regional Alarm:

mode of entrance:

Method 1: Enter the "Settings" icon in the upper right corner of the interface, click the

alarm setting option to enter the regional alarm interface.

Mode 2: Enter the home page, click the Settings icon on the right of the area name in the module at the bottom of the interface, as shown in Figure 1. You can enter the area alarm configuration interface of the area.

Default value: The regional alarm module corresponds to each statistical area. By default, there is only one statistical area 1, that is, there is only one statistical area 1 alarm configuration item by default; the number of people alarm switch is turned off by default. See Figure 2.

Alarm trigger unit: After turning on the alarm switch, it is displayed by default in seconds. It can be set in seconds, minutes and hours.

Alarm trigger time: After the alarm switch is turned on, it will be displayed by default. The default value is 30 seconds. The range of second setting is 0~3600, the range of minute setting is 0~60, and the range of hour setting is 0~1. Set according to actual requirements.

Alarm trigger condition: After the alarm switch is turned on, it is displayed by default as less than, and the condition can be selected as greater than or less than.

Number of people who trigger the alarm: After turning on the alarm switch, it is displayed by default as 1 person. The number range is 0 to 16 people.

Note: After the alarm switch is enabled, it will only be triggered when all alarm triggering conditions are met in the statistical area

Trigger an alarm. When the alarm is triggered, the color of the statistical area changes from light blue to pink.

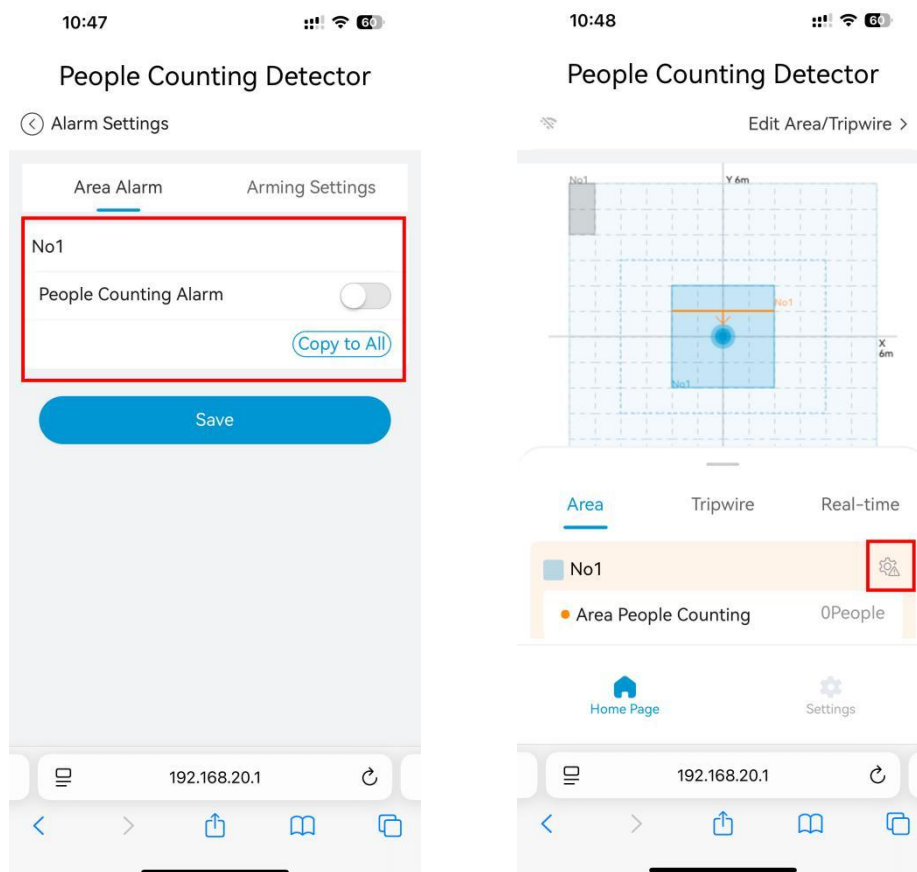

6.1.2 Deployment Settings:

mode of entrance:

Method 1: Enter the "Settings" icon in the upper right corner of the interface, click the alarm Settings option, and then click the deployment Settings option to enter the regional alarm interface.

Default value: The default configuration of personnel exceeding the deployment setting and personnel insufficient for the deployment setting exists. See Figure 1 for details.

The number of people exceeds the deployment setting: Enter the overcapacity deployment setting interface, and select all the time and date by default. See Figure 2 for details. When the trigger condition of the regional alarm configuration is greater than, the overcapacity deployment setting function is used.

Insufficient personnel for deployment: Enter the interface of deployment with fewer personnel, and select all time and date by default. See Figure 3. When the trigger condition of regional alarm configuration is less than, the function of deployment with fewer personnel is used.

Security Deployment Usage Rules: When using the security deployment function, alarm statistics in the designated area will only trigger an alarm if the alarm conditions specified in the area configuration and the date and time settings in the deployment are met. If the alarm conditions are met but not during the deployment time, no alarm will be triggered for that area. When the security deployment date and time are blue, it indicates a deployed state; if they are white, it indicates an undeployed state. Each deployment period supports up to 4 periods per day;

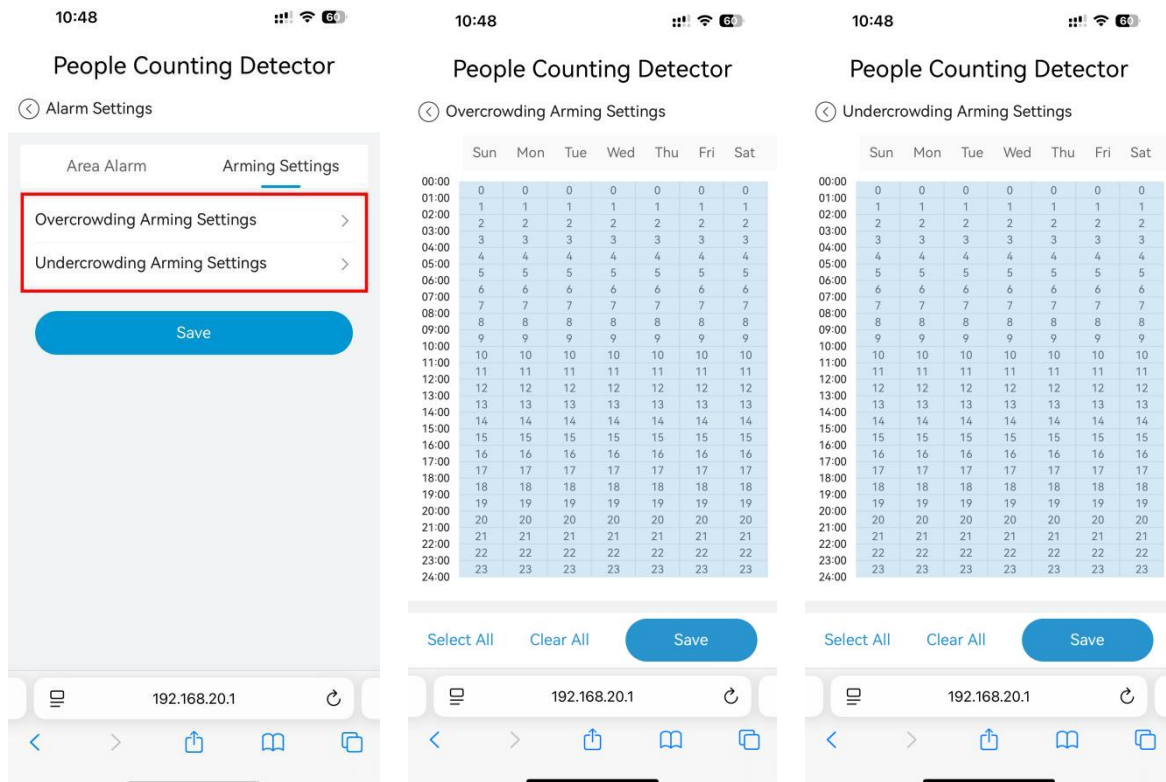

6.2 The Report Configuration is Detailed

Access mode: Click the "View" icon in the upper right corner of the page to enter the report export interface.

Default value: see Figure 1

Report content: Report content selection: Enter or leave, select the corresponding mode (enter or leave), and the exported report content is the corresponding enter or leave data. Select according to actual requirements.

Report time: The report time cycle can be selected: day, week, month, and the time can be set according to actual requirements.

Report preview: The report preview data is mainly presented according to the set report time cycle, which can be previewed by day, week or month.

Export report: Export statistical data tables according to the configuration content.

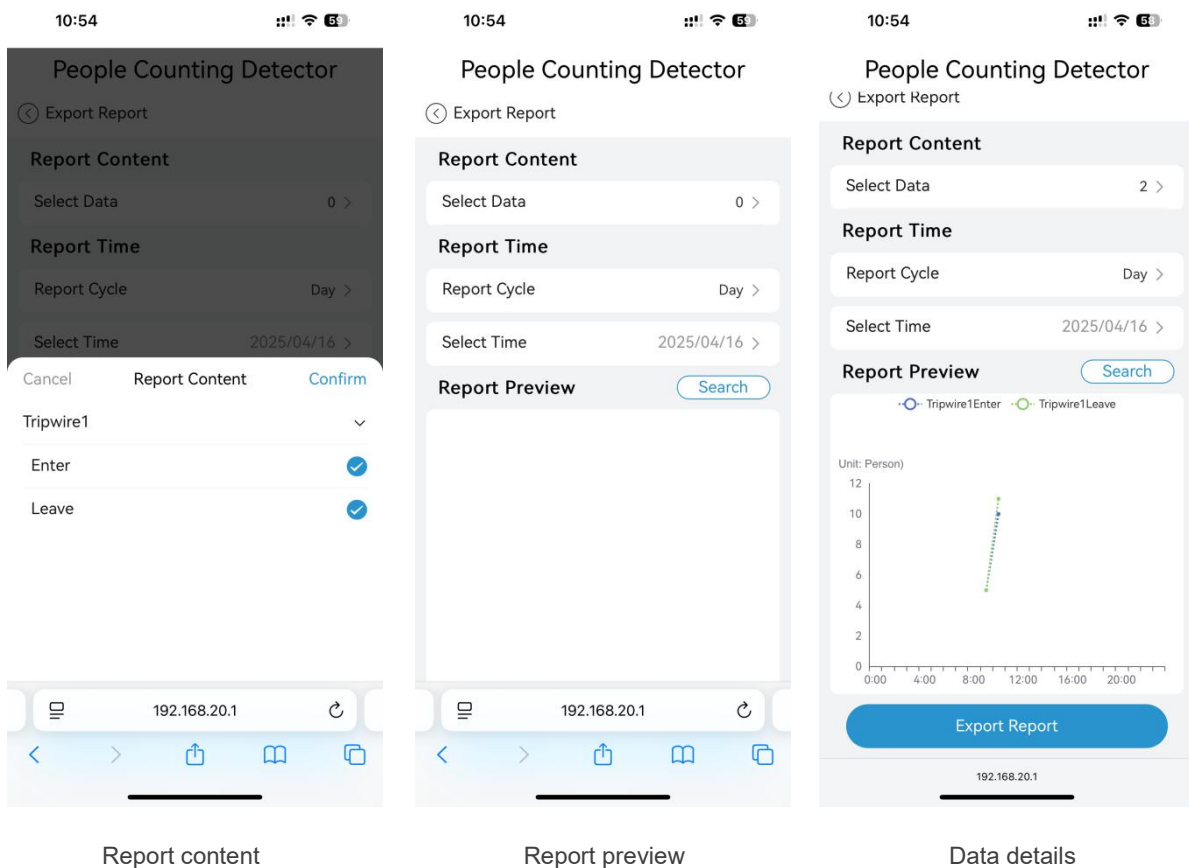

Statement

**Copyright © 2011- 2024 Chengdu Huaxin Zhiyun Technology Co., Ltd.
Copyright All Rights Reserved**

- Without the explicit written permission of Chengdu Huaxin Zhiyun Technology Co., Ltd., no organization or individual may reproduce, copy, transcribe or translate part or all of the contents of this manual without authorization, and may not disseminate it in any way (electronic, photocopying, recording, etc.) for profit-making purposes.
- **FOORIR** It is a registered trademark of Chengdu Huaxin Zhiyun Technology Co., Ltd. All trademarks mentioned in this manual are owned by their respective owners.
- The product specifications and information mentioned in this manual are for reference only. If there is any content update, no further notice will be given. Unless otherwise agreed, this manual is only used as a guide, and the statements made do not constitute any form of warranty.

Notice

- The parameters used in the screenshots shown in this manual are only used as setting examples for reference and may not be completely consistent with the actual situation. Please set the parameters according to your actual needs.
- The housing is prohibited from being disassembled during operation. Anti-disassembly reminder: Be careful when manually disassembling the housing of the device to avoid damage to the device. This is a Class A product. In a living environment, this product may cause radio interference. In this case, the user may need to take practical measures to deal with the interference.
- Due to different software versions, the screenshots shown in this manual may not be completely consistent with the device interface of the product you purchased. Please configure your product according to the actual device interface.
- If you find that there is a shortage or damage to any accessories, please contact your local dealer in time. The product pictures/screenshots in this manual are for reference only and are intended to help users install and configure the product. Please refer to the actual product/actual interface for details.



For assistance, please contact:

Manufacturer: Chengdu Huaxin Zhiyun Technology Co., Ltd.

Phone/WhatsApp: +86 18981978865

E-mail: info@foorir.com

Website: www.foorir.com